

*HIGH PERFORMANCE IN  
ALL CONDITIONS*

# Cutting Table

HALDRUP head

 HALDRUP USA





# INCREDIBLE VERSATILITY

---

## HALDRUP CUTTING TABLE

ONE OF THE MOST IMPORTANT FEATURES IS THE AIR INJECTION SYSTEM ON THE LEFT AND RIGHT SIDE OF THE HEAD, ALONG THE CUTTER BAR AND ALSO AT THE JUNCTION WITH THE FEEDERHOUSE. THIS ALLOWS CONTINUOUSLY CLEAN BETWEEN PLOTS AVOIDING SEED CONTAMINATION.



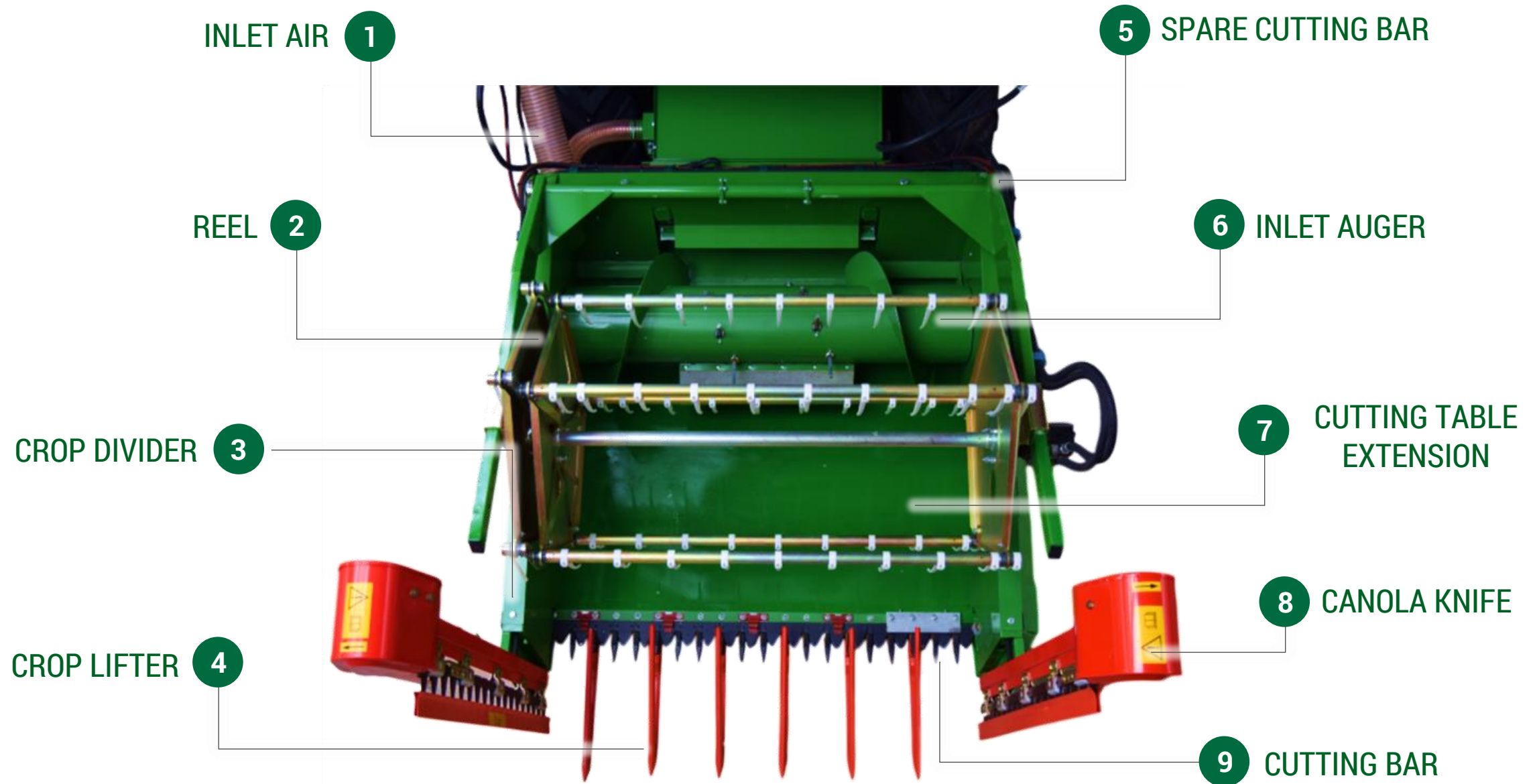

ON THE OTHER HAND, ITS OPERATION IS CONTROLLED FROM THE CABIN AS WELL AS MOST OF THE SETTINGS.

NUMEROUS OPTIONS ARE AVAILABLE SUCH AS VERTICAL CUTTER KNIVES, CUTTING TABLE EXTENSION, REEL DEPTH ADJUSTMENT, CONVEYOR BELT, FLOATING SYSTEM, BRUSHES, ETC.



# CLEAN UP TO THE LAST SEED

## HALDRUP INLET AIR

-  HIGH PRESSURE AIR BLOWER INPUT.
-  3 SPECIFIC POINTS:
  - ALONG THE CUTTING BAR.
  - LEFT AND RIGHT SIDE OF THE INLET AUGER.
  - CUTTING TABLE-FEEDERHOUSE JUNCTION.
-  AIR REGULATOR ON THE LEFT AND RIGHT SIDE OF THE INLET AUGER.
-  \*CONTROLLED BY HARVEST MANAGER.

*\*Optional*



5 BARS.



CONTINUOUS HYDRAULIC CONTROL OF SPEED (0 – 40 RPM) FROM THE CAB.



HEIGHT HYDRAULIC CONTROL FROM THE CAB.



\*HYDRAULIC HORIZONTAL ADJUSTMENT FROM THE CAB.



FINGERS: PLASTIC WHITE.



\*BRUSHES.

## MULTIPLE SETTINGS FOR YOUR OPERATION

### HALDRUP REEL

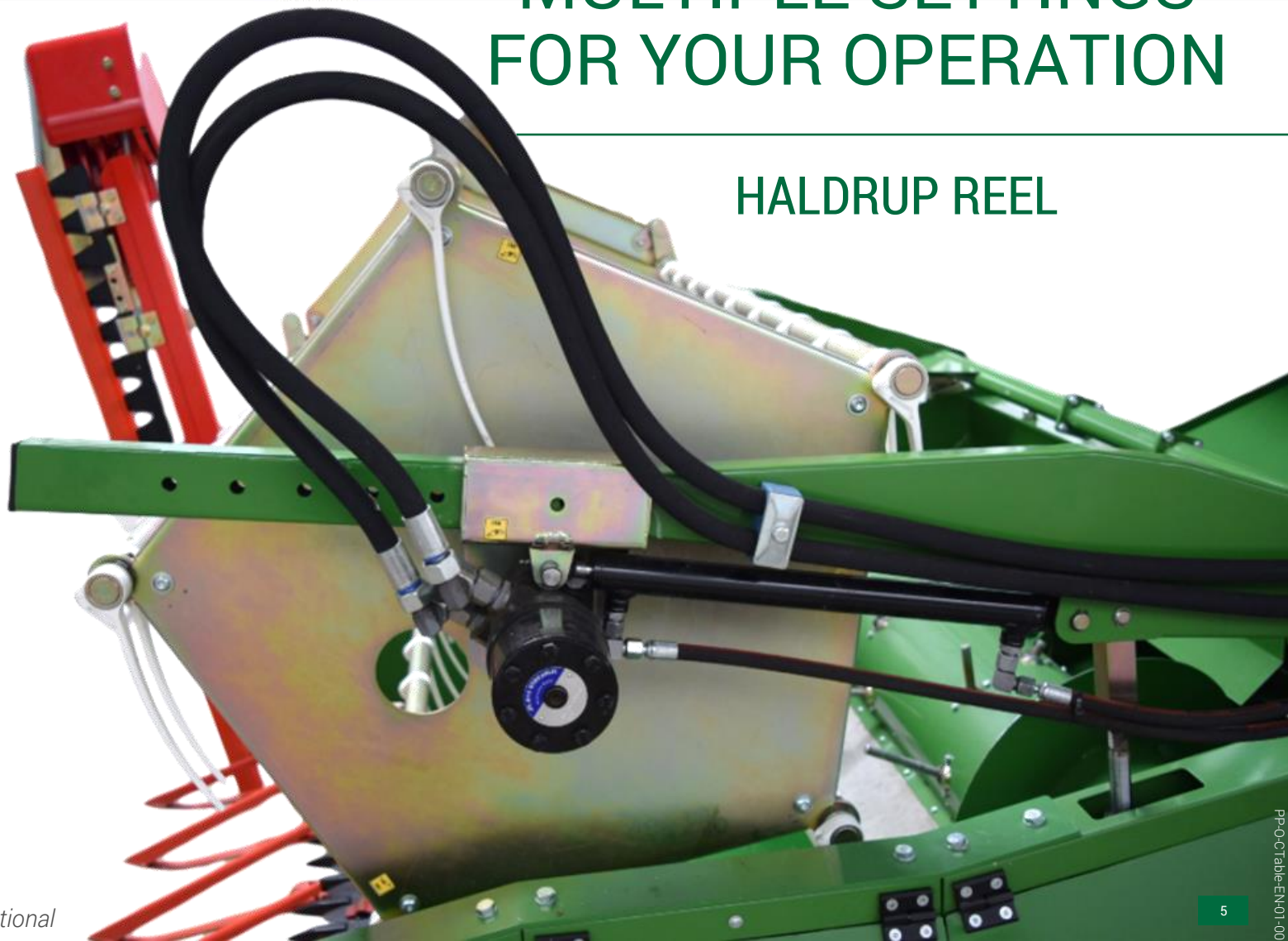

*\*Optional*

# AVOIDING CONTAMINATION BETWEEN PLOTS

---

## \*HALDRUP CROP DIVIDER

 POWDER-COATED STEEL.

 \*LONG OR SHORT VERSION.

 EASILY REMOVABLE.

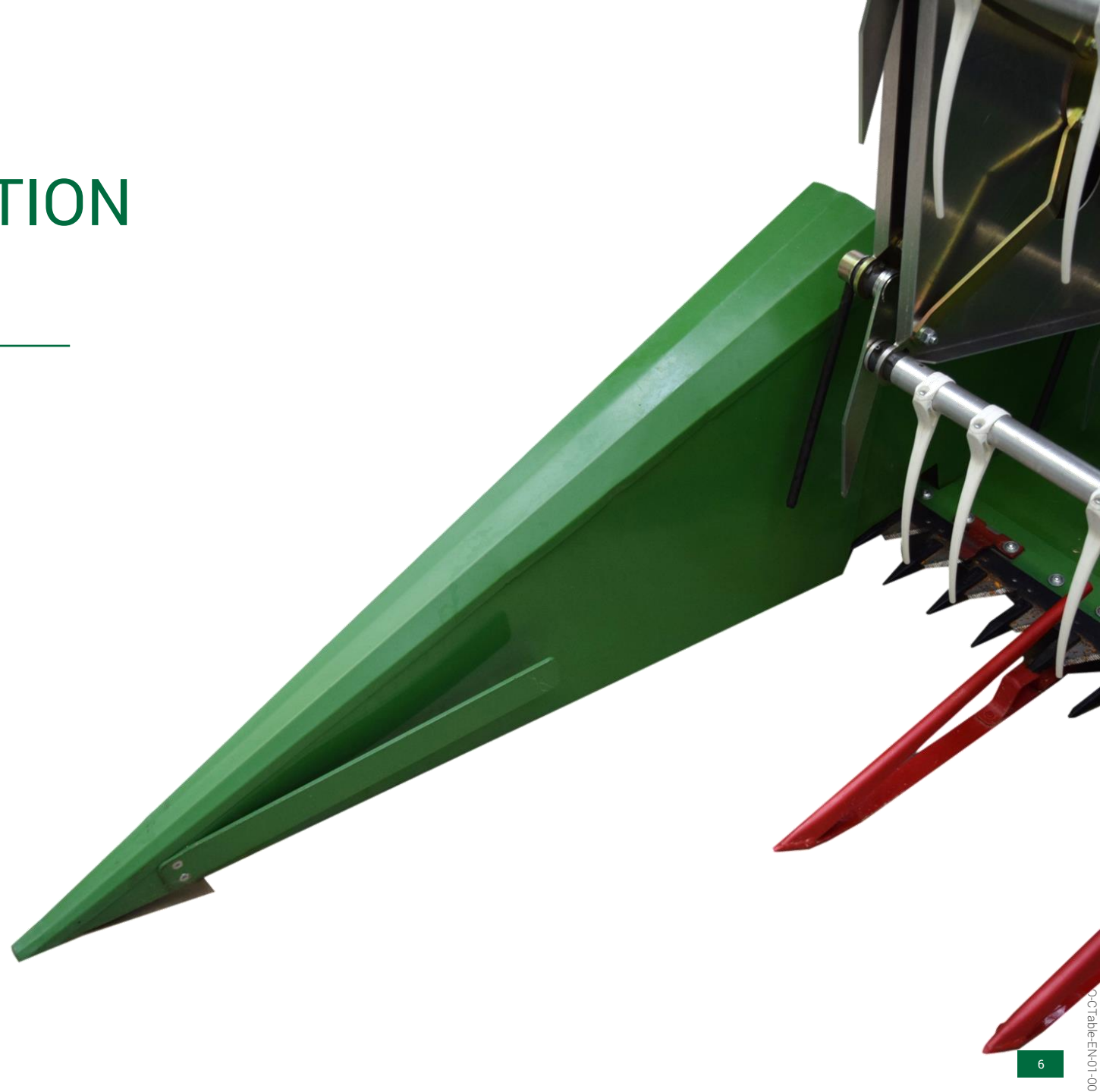





*\*Optional*

# EVEN IN THE MOST DIFFICULT CONDITIONS

---

## HALDRUP CROP LIFTER



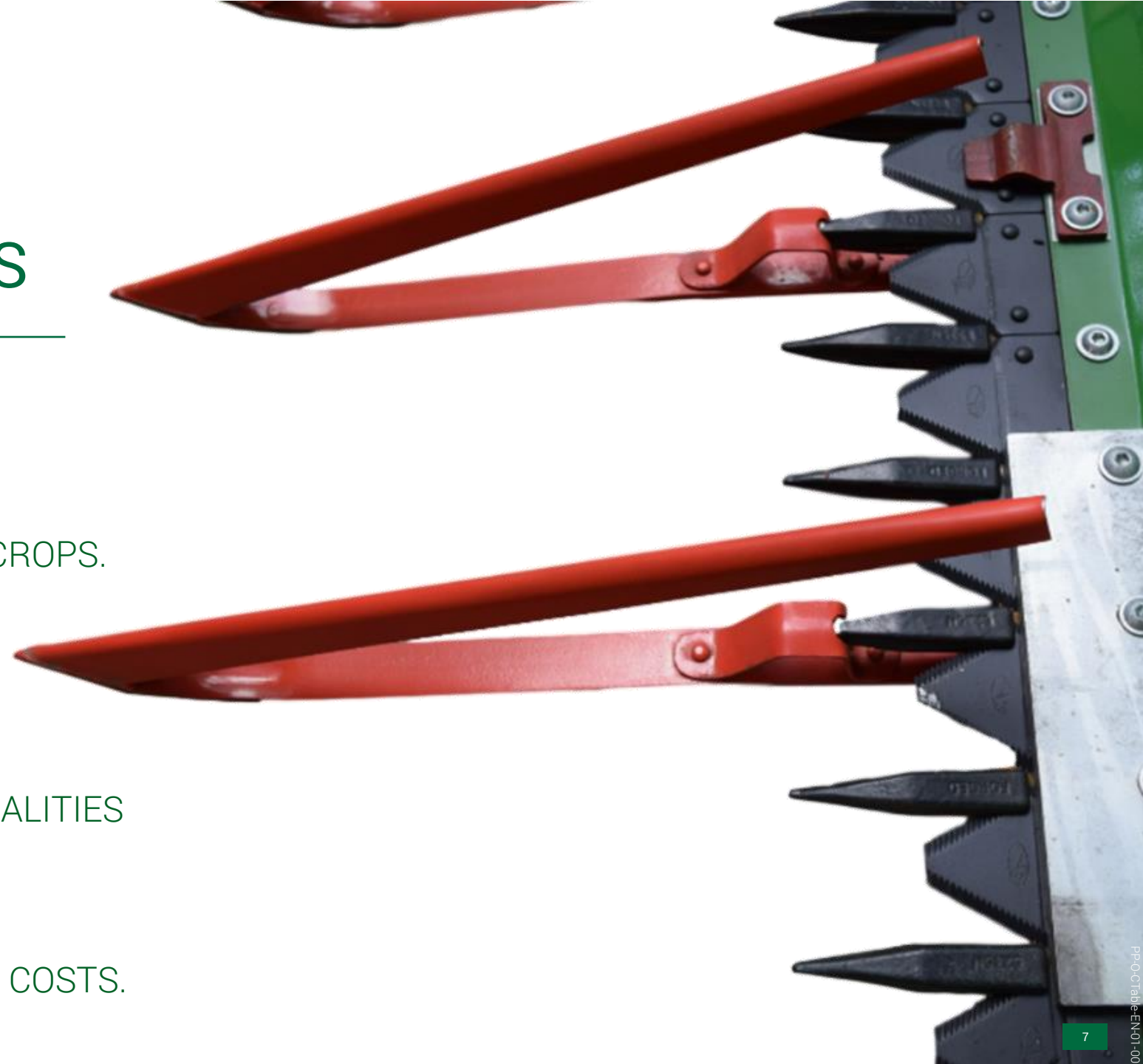

-  SUITABLE FOR WORK IN DIFFERENT CROPS.
-  ATTACHED WITHOUT TOOLS.
-  EXCELLENT GLIDING AND LIFTING QUALITIES  
REDUCE LOSSES.
-  HARD WEARING, LOW REPLACEMENT COSTS.



# WORK NO MATTER WHAT HAPPENS

---

## HALDRUP SPARE CUTTER KNIFE

-  COST FREE.
-  INSERTS INTO THE FRAME OF THE CUTTING TABLE.
-  PROTECTION COVER.
-  EASY TO REPLACE.

*\*Optional*



# A DYNAMIC AND CONSTANT FLOW

## HALDRUP INLET AUGER

 RETRACTILE / FIXED FINGERS.

 REVERSE MODE.

 HEIGHT ADJUSTMENT.

 POWDER COATED STEEL.



# BECAUSE SOME CROPS NEED IT

## HALDRUP CUTTING TABLE EXTENSION

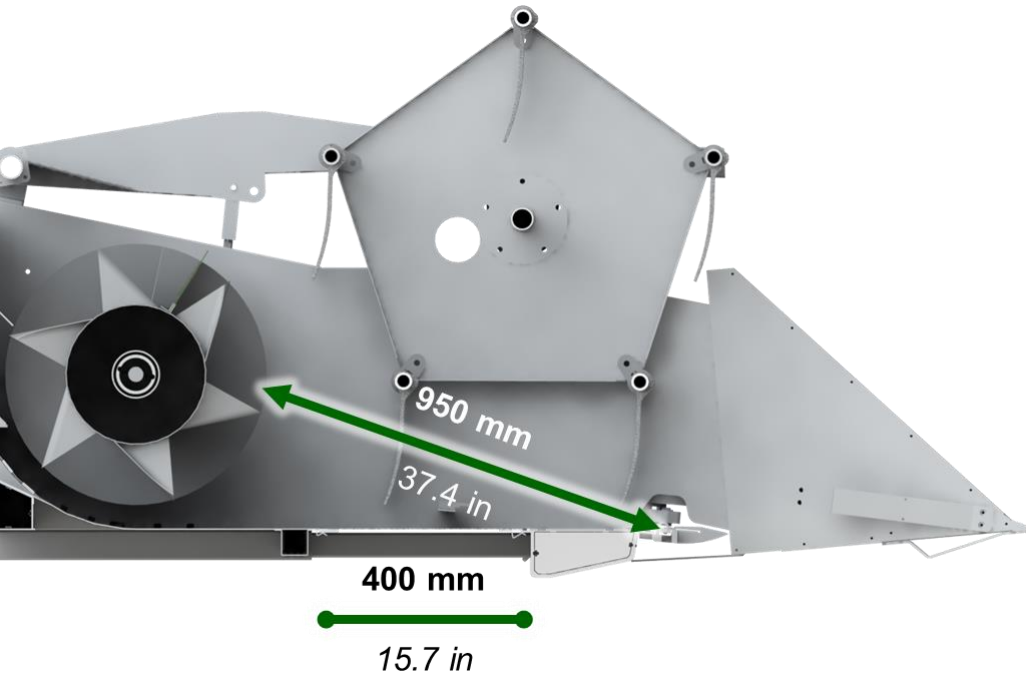
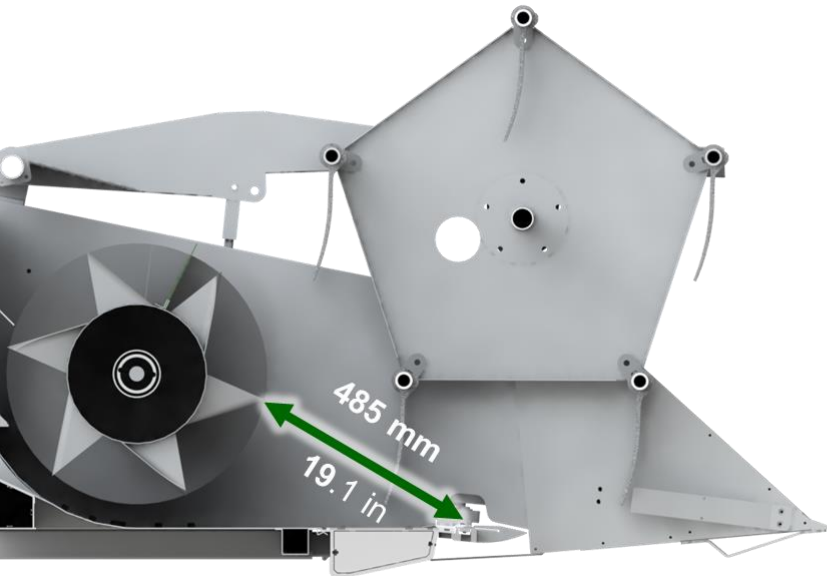

MAINLY FOR CANOLA.



EXTENSION LENGTH: 15.7 IN (400 MM).







STEEL WITH POWDER COATING.



QUICK ASSEMBLY AND DISASSEMBLY.

# AVOIDING CONTAMINATION OF NEIGHBORING PLOTS

## HALDRUP CANOLA KNIFE

-  \* LEFT / RIGHT / LEFT AND RIGHT.
-  ELECTRIC DRIVE.
-  POWERFUL SPECIAL DOUBLE KNIFE SYSTEM.
-  CUTTING HEIGHT: 53.1 IN (135 CM).





*\*Optional*

# HIGH PRECISION IN CUTTING

---

## HALDRUP CUTTER BAR

-  HYDRAULIC DRIVEN.
-  CUTTING HEIGHT: FROM 1 IN. (25 MM).
-  \*SPEED ADJUSTMENT.

*\*Optional*

 HALDRUP USA



# HALDRUP USA CORP.

---

425 INDUSTRIAL PARKWAY  
OSSIAN, IN 46777  
USA

+1 (844) 694 – 6205

*Info.usa@haldrup.net*

[www.haldrup.net](http://www.haldrup.net)